

AVOLO M A 1 SP 3F



TECHNICAL DETAILS

- Housing:** Pressed formed steel
Diffuser: Opal glass
IP: 40
IK: 02
 • Lamp replacement without tools

Colors

- | | | | | |
|---|---|--|---|---|
|  |  |  |  |  |
| -10
White | -20
Black | -30
Grey | -40
Gold | -75
Titanium |
|  |  | | | |
| -55
Inox | -26
Copper | | | |

Lighting Sources



- Classic / E27 / 230V** LED Lamp
Classic/E27/230V Halogen Lamp

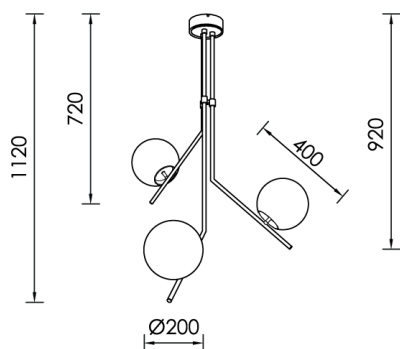

Lighting

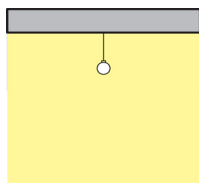

Headoffice - Showroom: 13 Sofokli Venizelou Ave., Likovrisi, P.O. Box 14123, Athens, Greece. Tel: +30 210 28 51 304 Fax: +30 210 28 51 306

Factory - Financial Services: 5 Kefalovrisou Str., Monomati, Aharnai, P.O. Box 13677 Athens, Greece. Tel: +30 210 62 08 230 Fax: +30 210 62 08 262

website: www.bright.gr | **e-mail:** info@bright.gr